

# MOEN® 摩恩®

## 智能坐便器 新瑞达系列

安装说明书

### Intelligent Toilet FIESTA Series

#### INSTALLATION INSTRUCTIONS

如需安装支持、配件替换，或遇配件丢失等情况，请联系本公司。

对于中国大陆以外的市场，请咨询当地经销商。

(中国大陆) 400-630-8866

(中国大陆) www.moen.cn

(中国大陆以外) www.moen.com.hk

For installation support, replacement parts, or missing items, please contact us.

For consumers in markets outside the Chinese mainland, please consult the local dealer.

(Chinese Mainland) 400-630-8866

(Chinese Mainland) www.moen.cn

(Outside Chinese Mainland) www.moen.com.hk



图片仅供参考  
(款式因型号而异)

Image is for reference only  
(Style varies by model)

#### 推荐工具

为了安全和让安装和替换变得容易，本公司建议您使用以下工具：

#### HELPFUL TOOLS

For safety and ease of installation and replacement, the company recommends the use of the following tools:



记录购买的型号：  
(保存安装说明书以备将来参考)

Record Purchased Model Number:  
(Save instruction sheet for future reference)

## 功能表 Function Table

功能分类 Functional Classification	功能 Function	型号 Model	SW1394C/D 枪灰 Gun Grey
冲水类 Washing	虹吸冲水 Siphon Flushing		●
	易洁釉面 Easy Clean Glaze		●
	预润净瓷 Pre-flushing		●
	遥控冲水 Remote Control Flushing		●
	离座冲水 Automatic Flushing		●
	烘干冲水 Wind Drying with Flushing		●
	侧边键冲水 Side Button Flushing		●
	停电冲水 Emergency Flushing		●
	摩力盾 Bubble Shield		●
清洗类 Cleaning	前置过滤 ( 不锈钢网 ) Pre-filter ( Stainless steel mesh )		●
	臀洗 Rear Wash		●
	妇洗 Front Wash		●
	一键清洗 One-touch Control		●
	往复清洗 Moving Wash		●
	气泡清洗 Air bubble Wash		●
	水压调节 Water-pressure Adjustment		●
	水温调节 Water Temperature Adjustment		●
	喷嘴位置调节 Nozzle Position Adjustment		●
	抗菌喷枪 Antibacterial Nozzle		●
灯光类 Lighting	LED夜灯 Night Light		●
	座圈加热 Seat Heating		●
	抗菌座圈 Antibacterial Seat		●
	暖风烘干 Wind Drying		●
	自动除臭 Automatic Deodorization		●
	喷嘴保养 Nozzle Maintenance		●
	座盖缓降 Soft-close Cover		●
	座圈缓降 Soft-close Seat		●
	便捷拆卸 Easy Disassembly		●
	来电自启 Auto-start		●
	智能节电 Smart Energy Saving		●
控制类 Controlling	自动断电 Automatic Power Off		●
	遥控控制 Remote Control		●
	旋钮控制 Knob Control		●
	电源开/关控制 Power Button		●
	侧边停止按键 Side Stop Button		●
	座圈感应 Sitting Sensor		●
	座温调节 Seat Temperature Adjustment		●
安全类 Safety	风温调节 Wind Drying Adjustment		●
	空气隔离 Air Isolation		●
	防止逆流 Anti Counterflow		●
	安全保护 Safety Protection		●

备注：● 代表产品有此功能。

Note: ● indicates that the product has this function.



## 物品清单 List of Articles



**1** 智能坐便器  
Smart Toilet

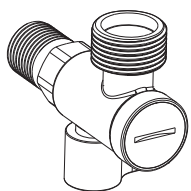

**1** 角阀  
Angle Valve

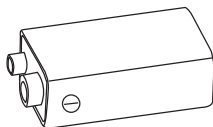

**1** 备用电池  
Spare Battery

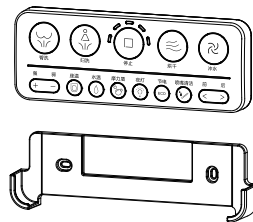

**1** 遥控器组件  
Remote Control Components

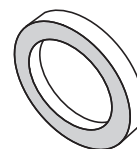

**1** 油泥  
Wax Ring

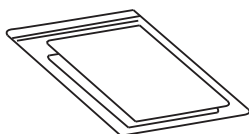

说明书、有害物质清单  
Manual, Hazardous Substance List

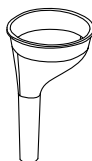

**1** 加液漏斗  
Dosing Funnel



**1** 清洗液  
Cleanser

※请确认包装内物品是否完整，如有缺失，请及时与我们的客户中心取得联系。

※以上物品图片仅供参考，以实物为准。

※Please confirm whether the contents of the package are complete. If there is any missing, please contact our customer center in time.

※Image is for reference only, style varies by model.

## 产品尺寸 Rough-in Dimension

本公司保留随时变更图中标示尺寸的权利，无需另行通知。

The company reserves the right to change the dimensions on the drawing without prior notice.

完工墙面  
Completion of metope

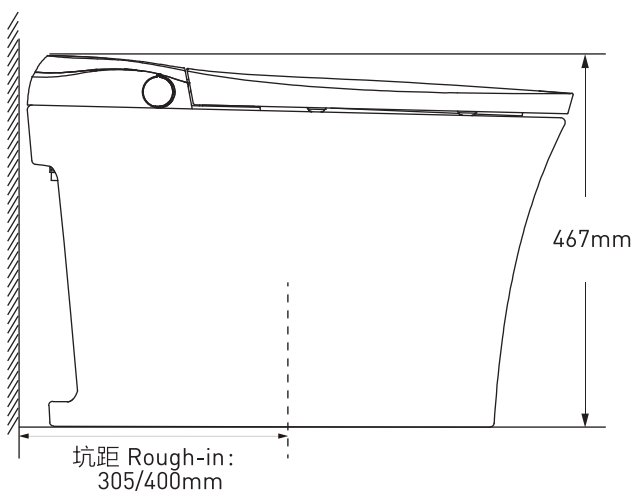

侧面图 Side View

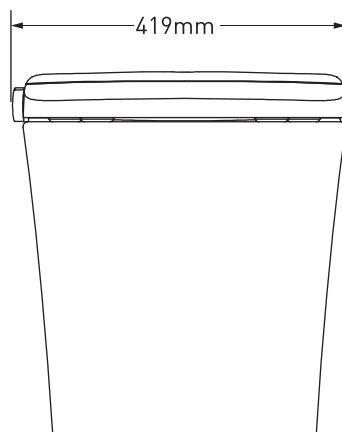

正视图 Front View

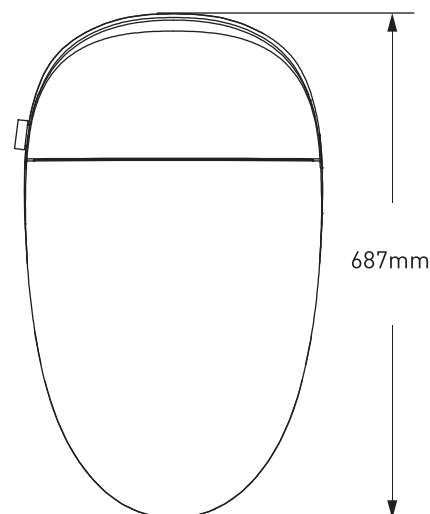

俯视图 Top View

# 产品安装 Product Installation

## 一.安装前注意事项

以下注意事项均与安全密切相关，根据不同情况可能造成重大后果，请您务必遵守。



警告:如果无视警告而误操作时，有可能造成人员伤亡。



注意:如果无视注意而误操作时，有可能造成人身伤害或财产损失。

## Precautions Before Installation

The following precautions are related to safety and may cause major consequences according to different situations. Please be sure to observe them.



Warning: If you ignore this warning and misuse it, it may cause casualties.



Notice: If you ignore this mark and misuse it, it may cause personal injury or property damage.

 <b>警告</b> <b>Warning</b>	使用的电源插座请在规定的范围内(交流220V ± 10%，最大电流10A以上)，使用超过插座规定时，会引起插座发热并引起火灾。 Please use the power socket within the specified range (AC 220V±10%,maximum current 10A or more). If it exceeds the specified socket, it will cause the socket to heat up and cause a fire.
	请确认是否进行了接地处理。(未接地的产品发生故障或漏电时可能会导致触电) Please confirm whether the grounding treatment has been performed. (Failure or leakage of ungrounded products may cause electric shock)
	危险!存在触电危险，在操作前应切断电源。 Danger! There is a risk of electric shock. Cut off the power before operation.
	谨慎!产品安装前，请关闭水源的总角阀，以免漏水导致财物损失。 Be careful! Before installing the product, please close the main of the water source to avoid water leakage and property loss.
	谨慎!存在有害气体的危险。如果坐便器不能立即安装，可在地面排污口上临时遮盖一块旧布。 Be careful!! There is a danger of harmful gases. If the toilet can not be installed immediately, a piece of old cloth can be temporarily covered on the ground drain.
 <b>注意</b> <b>Notice</b>	遵守所有的本地管道安装和电气规程，电源和水管应采用墙式安装方式。 Observe all local plumbing and electrical regulations. Power and water pipes should be wall-mounted.
	安装在浴室内的插座位置距离浴缸或淋浴喷头至少应为1.0米，但在任何情况下均不得小于0.5米。 The location of the socket installed in the bathroom should be at least 1.0m away from the bathtub or shower head, but should be more than 0.5m.
	仔细检查坐便器有无损坏。 Check carefully whether the toilet is damaged.
	连接水管前，请先彻底冲洗供水管以清除管道中的杂质； 使用市政自来水或可供饮用水作为接入水源。 请勿使用海水、再生水等，以免引起皮肤不适或设备故障。 Before connecting the inlet pipe, rinse the water supply pipe thoroughly to remove impurities. To avoid skin irritation or equipment failure, use only municipal tap water or potable water as the water source for the device. Do not use other water sources such as seawater, reclaimed water, etc.

## 二.安装步骤 Installation Steps

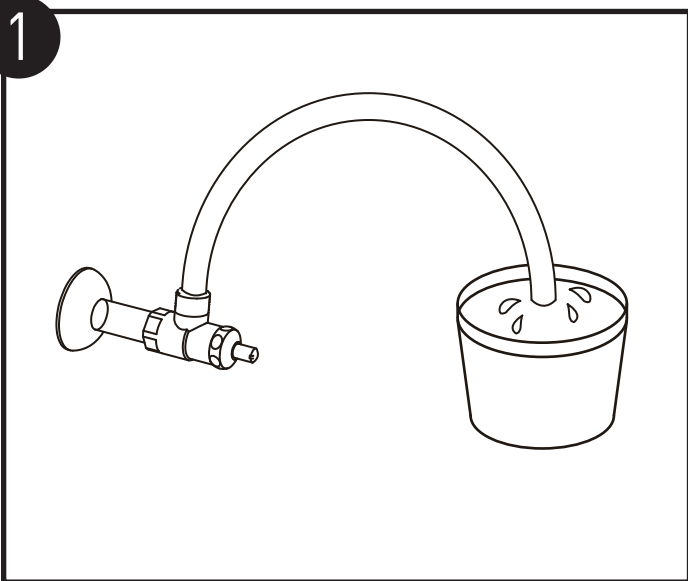

### 水压的确认

最低动态工作水压为0.14MPa(流动时18L/min 以上), 另外最高静态水压为0.75MPa (静止时)。未能满足此最低水压时,则无法达到最佳的冲水效果。

最低水压测定要领, 没有水压测定器的话, 可参考此方法。打开供水角阀,测量10秒钟流出的水量只要超过3升, 说明水压符合坐便器安装指标。(使用工具:秒表、量杯。)

Confirm the water pressure

Water Pressure: 0.14MPa (dynamic) - 0.75MPa (static).

If can't satisfy the min water pressure, the best flushing effect cannot be achieved.

The best way to test the min water pressure, without a water pressure tester, refer to this method.

Open the water supply angle valve, measuring the amount of water flow rate within 10 seconds. If it exceeds 3 liters, it indicates that the water pressure meets the installation index of the toilet.

(Use tools: stopwatch, measuring cup.)

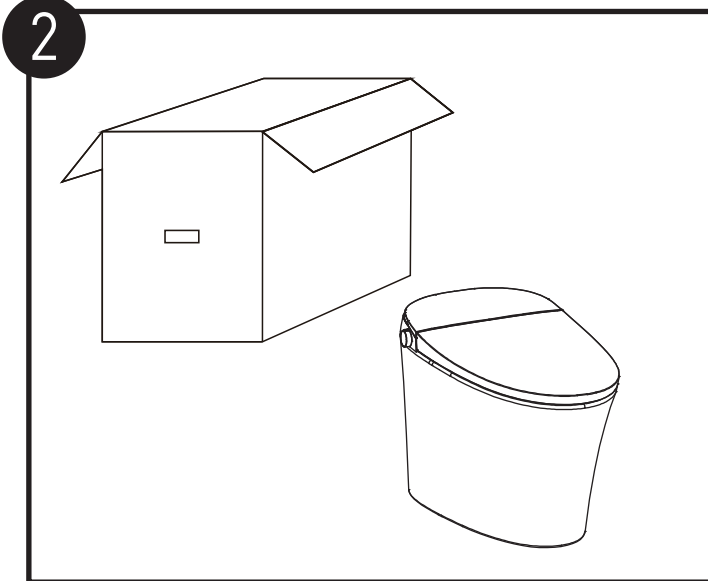

### 取出坐便器

打开纸箱, 将相关配件放置在一边, 再将坐便器取出。

Take out the toilet

Open the carton, put the relevant accessories aside, and then take out the toilet.

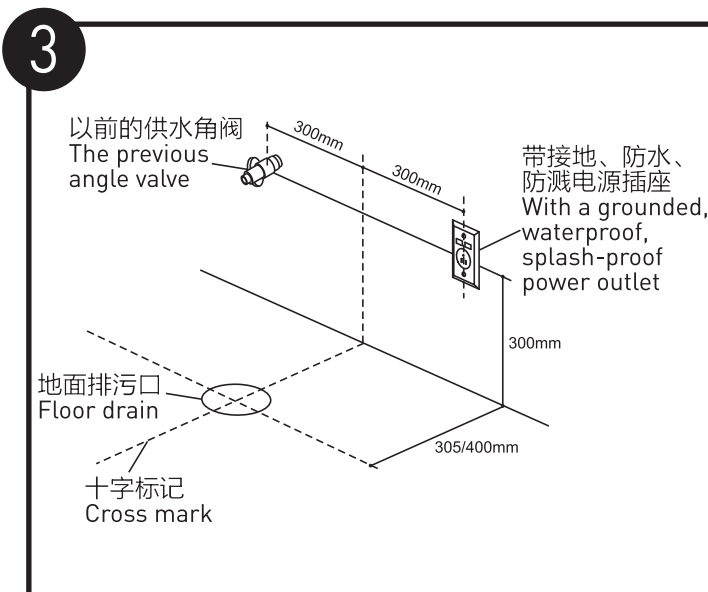

在地面排污口上画十字标记

将地面清洁干净, 同时将水分擦干。

Make a cross mark on the floor drain

Clean the floor and dry the water.









# 使用说明 Use Instructions

## 一.安全注意事项

### 使用前请仔细阅读

感谢您购买本公司的产品,为了您更好的享用本产品,请仔细阅读本说明书后正确使用,阅读完毕后请妥善保管。此处列出的注意事项是与安全相关的重要内容,根据不同情况可能造成重大后果,所以请您务必遵守。

## Safety Precaution

### Read all instructions before use

Thanks for purchasing our products. In order to make a better use of the product, please read this manual carefully and install the product correctly. Keep this manual properly for future reference.

The below precautions are important for safe use, and would cause serious consequence under different circumstance. Be sure to follow them.

## 用语及记号说明 Terms and Symbols

**警告** —— (表示如果无视此标志而误操作时,有可能造成人员伤亡。)  
Warning Ignorance would result in body injury or death.

**注意** —— (表示如果无视此标志而误操作时,有可能造成人身伤害或财产损失。)  
Caution Ignorance would result in body injury or property loss.

 —— (注意!与上述的“警告”、“注意”并用,请您务必严格遵守。)  
Attention! Used under the above “Warning” or “Caution” column, be sure to comply.

 —— (禁止这样做! )  
Prohibited Action!

 —— (请勿私自拆卸! )  
Do not dismantle!

 —— (请避免安装在潮湿及已浸到水的浴室内使用! )  
Keep away from direct water splashing or in damp environment!

 —— (请不要用手触摸所指示的位置! )  
Do not touch!

 —— (请不要用湿手触摸所指示的位置! )  
Do not touch with wet hands!

 —— (请远离火源! )  
Keep away from fire!

 —— (请按说明操作! )  
Operation should follow the manual!

 —— (请拔出电源插头! )  
Unplug the product!

 —— (保护接地! )  
Confirm the grounding!

# 警告Warning

本产品必须可靠接地。

※否则可能会因故障或短路而导致触电。

※当不确定时，请联系电器安装公司。

The product should be electrically grounded appropriately.

※Not doing so may cause electric shock due to malfunction or short circuit.

※Contact local power supplier, if the power supply is not installed properly.



请勿将点燃的香烟及其他燃烧物投入坐便器内。

※否则容易发生火灾。

Do not throw the lit cigarettes or other burning things into the toilet.

※Otherwise fire hazard may occur.



请勿用湿手触摸或插拔电源插头。

※否则有触电的危险。

Do not touch or plug the power plug with wet hands.

※Otherwise electric shock may occur.



请勿在雷电天气下使用（在附近发生雷电时，请拔下电源插头）。

※否则可能会引发事故或发生故障。

Do not use during the thunderstorms(When there has thunderstorms nearby, please unplug the toilet)

※Otherwise accidents or toilet malfunction may occur.



请勿使用不良的电源插座或破损的电源插头。

※否则接触不良、破损等导致触电或引发火灾等危险。

Do not connect a broken power cord into the power supply.

And avoid loose connection.

※Loose connection or broken cord would cause electric shock or fire hazard.

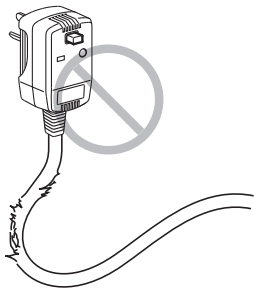
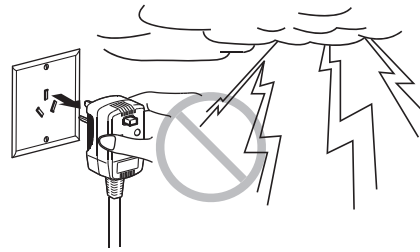

座圈与盖板发生损坏时，为了避免危险请您务必拔掉电源插头、关闭水源，并请联系当地经销商进行更换。

※否则容易发生触电、火灾的危险。

When the lid or seat plate damaged, unplug the toilet, close the water shutoff valve, and contact the local AD to replace.

※Otherwise electric shock or fire hazard may occur.



使用的电源插座请在规定的范围内

（交流220V ± 10%，最大电流10A以上）。

※否则容易引发火灾、触电。

The used of power supply should be within the specified scope [AC 220V±10%, rated current 10A or above].

※Use of the power supply other than the above scope would cause electric shock or fire hazard.



请定期将电源插头拔下，用干布擦拭电源插头上的灰尘。

※否则当绝缘不良时，会引发火灾。

Unplug the power plug regularly, wipe away the dust with a piece of dry cloth.

※Negligence in dust clean would cause short cut which leads fire hazard.



身体、感知、智力能力缺陷或经验和常识缺乏的人（包括儿童），请在有人陪同下使用。

※否则长时间使用，有可能造成低温灼伤。

A close supervision is required for children, elderly, patients, retarded and disabled people to use this toilet.

※Long using may cause low temperature burn.

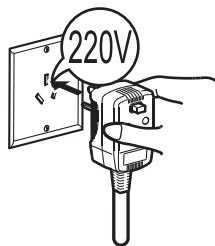

请勿把电源线随意拉拽、破损、强行弯曲和扭曲、拉伸、卷曲、打捆、承重、过度夹挤。

※否则电源线破损会导致触电或火灾。

Do not pull, damage, bend by force, twist, tense, curl, knot, crimp the cord.

※Doing so would cause the broken of the cord, which would leads electric shock or fire hazard.



儿童不应玩耍本产品。

※否则可能造成人身伤害。

Do not leave your children playing with the product.

※Doing so may cause the children get injured.



如果电源线损坏，为了避免危险，必须由制造商、其维修部或类似部门的专业人员更换。

※否则容易引起触电、火灾。

Contact the manufacturer, customer service, or other qualified repairing center to replace the broken cord.

※Otherwise electric shock or fire hazard may occur.



非本公司售后维修人员或指定专业维修人员，严禁拆卸、修理、改装本产品。

※否则容易引发触电、火灾或异常运作造成人身伤害。

It is prohibited to dismantle, repair or retrofit the product except our customer service or authorized maintainer.

※Otherwise the electric shock, fire hazard, toilet malfunction or body injury would happened.



清洁保养塑料、金属部件时，请勿使用不适合的清洁剂（如浓硫酸、浓硝酸、冰醋酸、四氯化碳、氯仿、丙酮、丁酮、苯、甲苯、苯酚、甲酚、二甲基替甲酰胺、甲醚、大豆油、醋酸盐、40%硝酸、浓盐酸、95%酒精、汽油、煤油、刹车油、11%氢氧化钠、23%氢氧化铵、去污剂TritonX-100等）。

※否则可能导致塑料部件开裂、金属部件生锈等问题，造成人身伤害、触电或火灾等危害。

Do not use unsuitable cleaners for cleaning and maintaining plastic parts, metal parts [Such as concentrated sulfuric acid, concentrated nitric acid, glacial acetic acid, carbon tetrachloride, chloroform, acetone, butanone, benzene, toluene, phenol, cresol, dimethyl formamide, methyl ether, soybean oil, acetate, 40% nitric acid, concentrated hydrochloric acid, 95% alcohol, gasoline, kerosene, brake oil, 11%NaOH, 23%NH<sub>4</sub>OH, detergent TritonX-100, etc.].

※Otherwise, it may lead to problems such as cracking of plastic parts and rusting of metal parts, causing personal injury, electric shock or fire and other hazards.



请勿使用工业用水或污染的水源。

※否则有可能引发膀胱炎、皮炎及因机械内部腐蚀会引起触电、火灾。

Do not use industrial water or polluted water sources.

※Otherwise, it may cause cystitis, dermatitis and electric shock and fire due to internal corrosion of machinery.



请不要用力向后依靠、站立在盖板上，或粗暴开闭盖板、座圈，以免造成损坏。

※否则容易发生破损、造成人身伤害。

Please don't lean back forcibly, stand on the flip, or roughly open and close the flip, seat in order to avoid damage.

※Otherwise, it is easy to cause damage and cause personal injury.



请勿向坐便器或遥控器内部加水或清洁剂。  
请勿用水或清洁剂弄湿坐便器及电源插头。  
※否则可能会有触电和发生火灾的危险。



Do not add water or detergent to the toilet bowl or remote controller. Do not wet the toilet bowl or power plug with water or detergent.

※Otherwise, it is easy to cause electric shock or fire.

请避免安装在潮湿及易浸到水的浴室使用。  
请勿将水喷淋到本产品上面或用水冲洗，以防内部进水，造成损失。



※否则容易引发触电、火灾。

Please do not install it in the wet environment or in the bathroom with water. Do not spray water on the product or flush it with water so as to prevent water and losses.

※Otherwise, it is easy to cause electric shock or fire.

请勿将手或其他东西塞入暖风出口，在产品使用时请勿覆盖暖风出口。



※否则容易引起触电、火灾或异常运行造成人身伤害。

Do not put your hands or other things into the heater outlet.

Do not cover the heater outlet when using the product.

※Otherwise, it is easy to cause electric shock, fire or personal injury caused by abnormal operation.

请勿将小便射进暖风出口位置。

※否则会有触电的危险。

Do not urinate into the heater outlet

※Otherwise, it is easy to cause electric shock.



请按以下方法正确使用电池。



●请按“+”“-”正确安装电池。

●长时间不使用时请将电池取出。

●由于电池能量耗尽会影响信号的接收，请及时更换电池。

●废弃电池时，请用胶带等进行绝缘。

※否则电池中流出的液体可能会引发火灾。

●请将电池放置在婴幼儿够不到的地方。

※如果不慎吞入口中，请及时就医。

●电解液沾到身体上时，请及时用清水洗净。

●电解液不慎进入眼中时，请勿揉眼睛，应立即用清水冲洗并请立即就医。

※否则容易引发失明。

Please use the battery correctly as follows.

●Please reference “+”“-” to install the battery correctly.

●Remove the battery when not in use for a long time.

●As the battery energy exhaustion will affect the signal reception, please replace the batteries in time.

●When disposing of batteries, please insulate them with tape, etc.

※Otherwise, the liquid flowing out of the battery may cause a fire.

●Keep the battery out of the reach of infants.

※If you accidentally swallow it in your mouth, please consult a doctor promptly.

●When the electrolyte gets on your body, please wash it off with water in time.

●If electrolyte enters your eyes accidentally, do not rub your eyes. Rinse them with clean water and seek medical attention immediately.

※Otherwise it is easy to cause blindness.

使用电池时，请勿进行以下操作。

●请勿与金属制品（项链、手表等）一起携带或保管。

●请勿混合使用新旧电池。

●请勿分解电池或将其投入水中、火中。

※否则电池中流出的液体可能会引发火灾。

When using the battery, do not perform the following operations.

●Do not carry or keep it with metal products (necklaces, watches, etc.).

●Do not mix old and new batteries.

●Do not disassemble the battery or throw it into water or fire.

※Otherwise, the liquid flowing out of the battery may cause a fire.



## 注意Caution

请勿长时间使用座温的“高”、“中”档。

※否则长时间使用会有烫伤的危险。

Do not use seat temperature, "high"、"medium" gear for a long term.

※Otherwise, it may have a risk of scald for long-term use.



请避免阳光直射或将取暖器靠近本产品。

※否则可能造成产品变色。

Keep the product away from direct sun light and heating apparatus.

※Otherwise, it may cause discoloration of the product.



拆卸过滤器时，请务必关闭供水角阀。

另外安装过滤器时，请用力拧紧。

※否则容易引起漏水。

Make sure to close water supply angle valve for the disassembly of the filter. Please tighten the filter for the installation.

※Otherwise, it is easy to cause water leakage.



为避免由热断路器的误复位产生危险，请勿通过外部开关装置供电，例如定时器或者连接到由通用部件定时进行通、断的电路。

Do not provide power supply through external switching device in order to avoid the danger caused by the false reset of thermal circuit breaker, such as the timing device, on and off circuit for timing connected to common components.



请使用本机附带的新软管组件，旧组件不能重复利用。如果随机配有其他的连接水源的器具，请一并更换。

※否则容易引起漏水导致财产损失。

Please use the new hose assemblies attached to this machine and the old assemblies cannot be reused. Please replace the appliances connected to water sources at random with the machine.

※Otherwise, it is easy to cause property loss due to water leakage.



出差或外出旅游等长时间不使用时，请您务必拔掉电源插头、关闭水源，并将产品内部积水排净。

※否则冻结内部积水引起的破损会导致火灾、漏水。

Please pull out the power plug, close the water sources and empty the water in the product for long-term business or trip.

※Otherwise, damage caused by internal water freezing will lead to fire and water leakage.



当突然停电时，请拔掉电源插头，关闭角阀，防止漏水。

※否则容易引起漏水导致财产损失。

Please pull out the power plug and close the angle valve in power failure to prevent water leakage.

※Otherwise, it is easy to cause property loss due to water leakage.



在寒冷的冬季，当产品在经过长途运输或长时间存放时，产品内剩下的积水可能会发生冻结现象。为预防冻结造成损失，请采取防冻措施。

※否则冻结内部积水引起的破损会导致火灾、漏水。

The remaining water in the product may freeze for long term transport or storage in cold winter. Please take anti-freezing measures to prevent damage caused by freezing.

※Otherwise, damage caused by internal water freezing will lead to fire and water leakage.



## 二.遥控器的使用说明 Remote Control Use Instructions

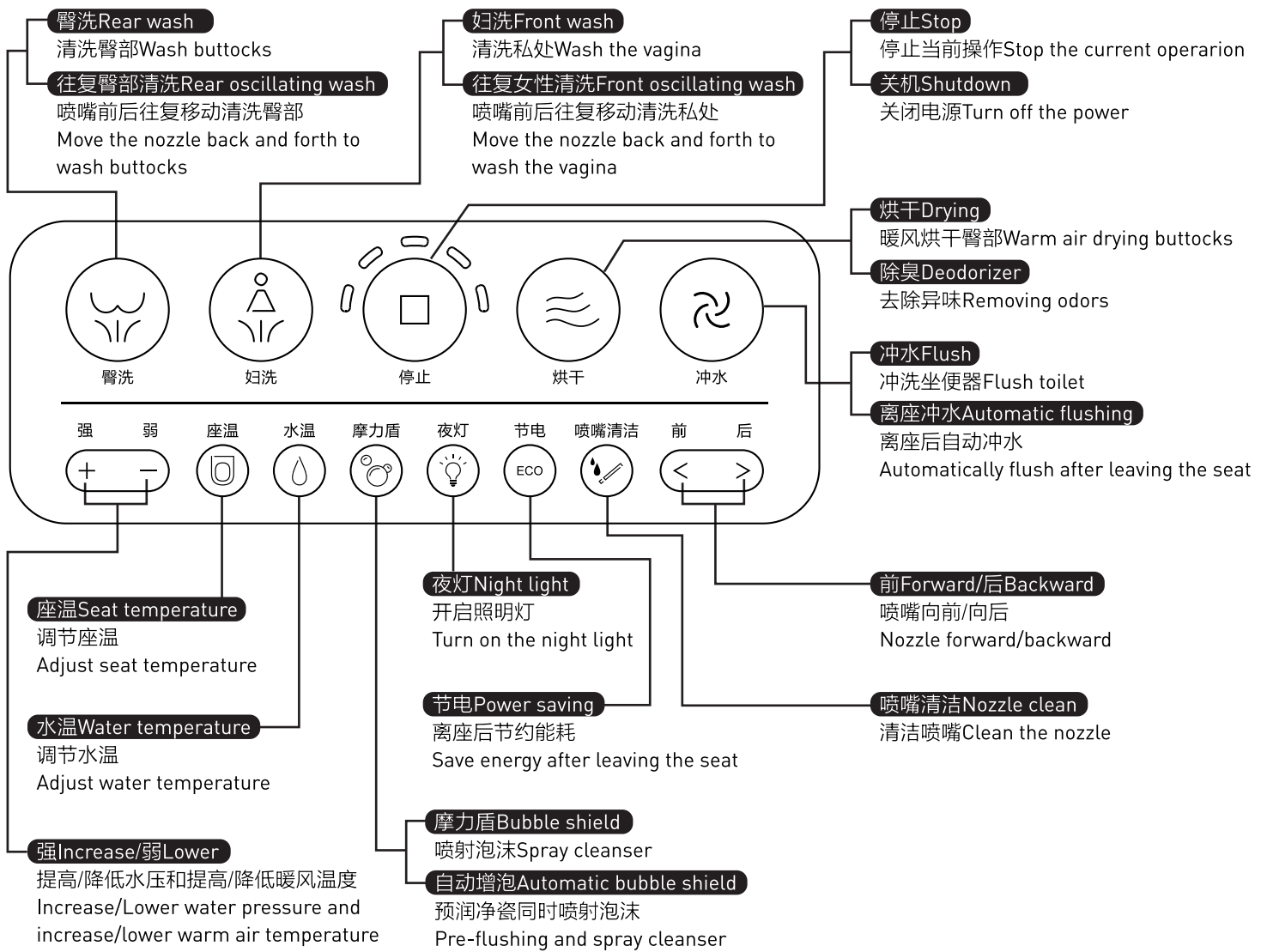

指示灯Indicator	指示灯状态 Indicator state	座温 Seat temperature	水温 Water temperature	喷嘴位置 Nozzle position	水压 Water pressure	风温 Wind temperature
	指示灯全熄 Indicator off	常温 room temp	常温 room temp	/	/	/
	1个灯亮 1 light on	33℃	33℃	1档 / 1 gear	1档 / 1 gear	1档 / 1 gear
	2个灯亮 2 lights on	/	/	2档 / 2 gear	2档 / 2 gear	2档 / 2 gear
	3个灯亮 3 lights on	36℃	36℃	3档 / 3 gear	3档 / 3 gear	3档 / 3 gear
	4个灯亮 4 lights on	/	/	4档 / 4 gear	/	/
	5个灯亮 5 lights on	39℃	39℃	5档 / 5 gear	4档 / 4 gear	4档 / 4 gear

## 遥控器对码

如果用户装有两台或以上同品牌智能坐便器，使用遥控器时可能会有相互影响的现象，此时使用遥控器对码功能，保证遥控器和产品的唯一性。执行对码操作时，必须将附近其他智能坐便器的电源插头拔掉。

1. 主机断电，遥控器待机；
2. 同时按遥控器的“摩力盾”和“夜灯”直到档位指示灯连续闪烁后松开；
3. 在5秒内给主机上电；
4. 遥控器指示灯停止闪烁，对码完成；

**注意:**遥控器对码时间为10秒，超时操作自动退出对码。



## Remote Control Code



If you have more than two items of the same brand smart toilet, there maybe interaction while using remote control. In this condition, use the remote control code matching function to match the remote control and the toilet. During match operation, you must unplug the power of other smart toilets nearby.



1. Plug off the smart toilet power.
2. Press "摩力盾" and "夜灯" button on the remote control at the same time, leave it until the indicator light constantly blinking.
3. Plug on the smart toilet in 5 seconds.
4. Match code completed when the remote control indicator light stop blinking.



**Note:** Remote control match code time is 10 seconds, auto quit if overtime operation.

## 三. 功能使用说明 Basic Use Function

按下  按键，清洗管伸出，清洗孔开始喷水进行臀洗；再次按下  按键，进入往复臀部清洗，清洗管前后往复移动进行清洗；再次按下  按键，停止往复清洗，切换回臀洗。

Press  button, nozzle reaches out to work, the cleaning hole starts to spray water for rear wash; Press  button again, change to rear oscillating cleansing, nozzle repeatedly swings back or front. Press  button again, stop oscillating cleansing, switch back to rear wash.

按下  按键，清洗管伸出，清洗孔开始喷水进行妇洗；再次按下  按键，进入往复女性清洗，清洗管前后往复移动进行清洗；再次按下  按键，停止往复清洗，切换回妇洗。



Press  button, nozzle reaches out to work, the cleaning hole starts to spray water for front wash; Press  button again, change to front oscillating cleansing, nozzle repeatedly swings back or front. Press  button again, stop oscillating cleansing, switch back to front wash.

臀洗Rear wash

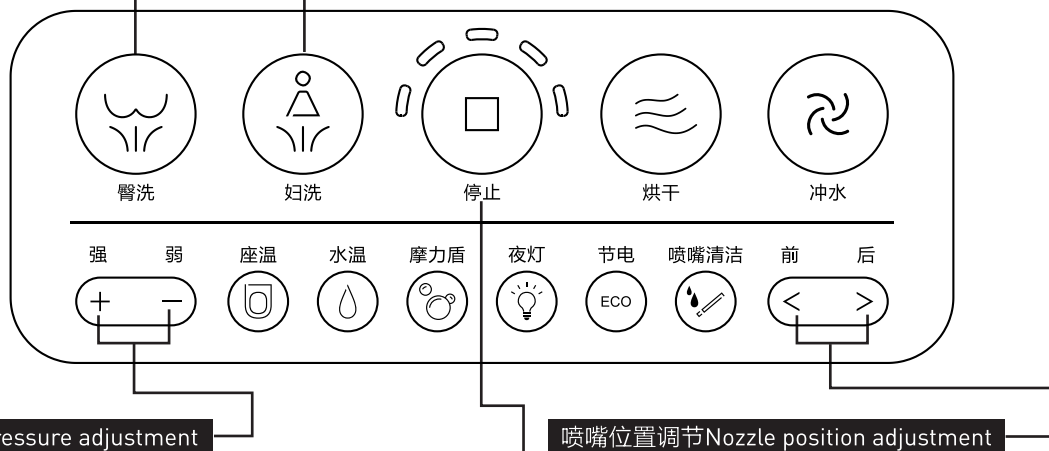

妇洗Front wash





水压调节Water pressure adjustment

4个档位可供选择，通过按压  两键调节清洗时的水压大小。  
4-paragraph for choosing, adjust comfortable water pressure by pressing .

喷嘴位置调节Nozzle position adjustment

5个档位可供选择，通过按压  两键调节清洗时喷嘴的位置。  
注意：在往复清洗模式下，不能进行喷嘴位置调节。  
5-paragraph for choosing, adjust satisfied position to clean by pressing .  
Note: Under oscillating cleaning, the nozzle position adjustment is unavailable.

停止清洗Stop cleaning

在清洗过程中按下  按键，停止当前清洗操作。臀洗/妇洗在运行2分钟后会自动停止。  
Press  button, stop the current cleaning operation during cleaning. If do not press  button, rear washing/front washing will stop automatically after 2 minutes.



水温共有4档可调，分别是常温档、低档33℃、中档36℃、高档39℃。每按压一次  按键，水温切换到下一档，顺序为中-高-中-低-常温-低-中，依次循环。

4 levels of water temperature are available, called normal temperature level, low level 33 C, medium level 36 C, high level 39 C. Each time you press  button, the water temperature will be adjusted, the sequence is medium-high-medium-low-normal-low-medium, and the cycle is in turn.

#### 水温调节 Water temperature adjustment

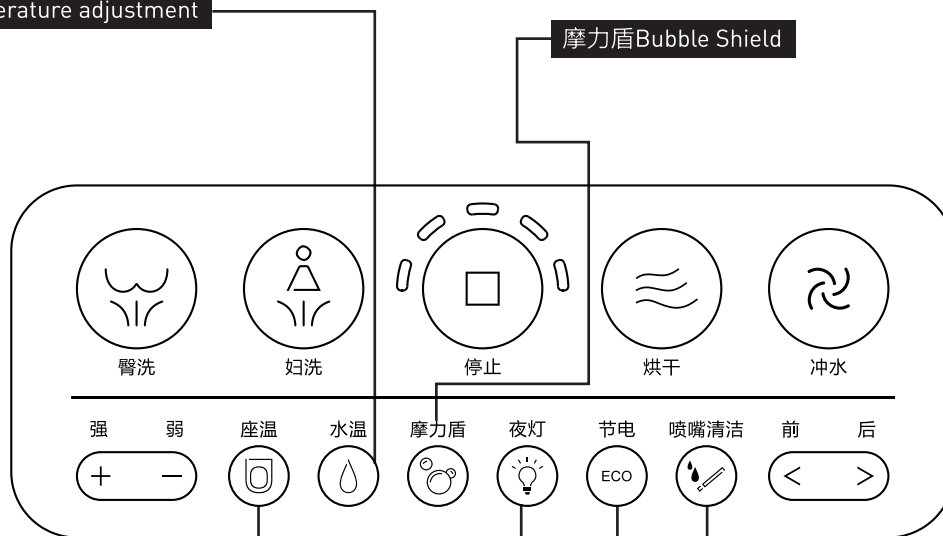

#### 座温调节 Seat temperature adjustment

座温共有4档可调，分别是常温档、低档33℃、中档36℃、高档39℃。每按压一次  按键，座温切换到下一档，顺序为中-高-中-低-常温-低-中，依次循环。

※为了防止低温灼伤，着座10分钟后机器自动将座温降低到35℃以下。



4 levels of seat temperature are available, called normal temperature level, low level 33 C, medium level 36 C, high level 39 C. Each time you press  button, the seat temperature will be adjusted, the sequence is medium-high-medium-low-normal-low-medium, and the cycle is in turn.



※In order to prevent low-temperature burns, the machine will automatically lower the seat temperature to below 35℃ after 10 minutes of sitting.

#### 夜灯 Night light

按下  按键，开启/关闭夜灯功能。

Press  button, turn on / off the night light function.

按下  按键，启动摩力盾，喷射一次泡沫液。长按  按键3秒，开启/关闭自动增泡，遥控器2号指示灯同步点亮或熄灭。自动增泡功能开启时，在预润净瓷的同时会喷射泡沫。

Press  button to start the bubble shield function and spray cleanser once. Press  button for 3 seconds, turn on / off the automatic bubble shield function. The No.2 indicator light of the remote control will turn on or off synchronously. After the function is turned on, it will automatic spray cleanser when in pre-flushing.

#### 摩力盾 Bubble Shield

#### 节电 Power save

按下  按键，开启/关闭节电功能，遥控器5号指示灯同步点亮或熄灭。当节电开启时，离座1.5分钟后，进入节电模式，座温保持在25℃。下次使用时，自动恢复节电前的设置。

Press  button, turn on / off the power save function. The No.5 indicator light of the remote control are on or off synchronously. When the power save is turned on, after leaving the seat for 1.5 minutes then enter power saving mode, seat temp is kept at 25 C and the settings before power saving are automatically restored the next time.

#### 喷嘴清洗 Nozzle clean

按下  按键，进入喷嘴清洗模式，喷口伸出开始流水。此时可以对喷嘴进行刷洗。

注意：喷嘴清洗在人未着座时有效。

注意：喷嘴在臀洗/妇洗前也会自动清洁喷嘴周边部分。

Press  button, enter nozzle cleaning, nozzle extends and water flows out. You can clean the nozzle at this time.

Note: Nozzle clean is effective when people are not seated.

Note: Nozzle will automatically clean the peripheral part of the nozzle before rear wash and front wash.



#### 蜂鸣器:

鸣一声: 着座状态, 可响应全部操作。

鸣两声: 离座状态, 可响应冲水、座温调节等部分功能。

鸣三声或以上: 表示产品有故障。

提示: 蜂鸣器仅在侧边旋钮、遥控器操作时或初始化排水时才会响起。

#### Buzzer

The buzzer beeps once: seated state, can respond to all operations.

The buzzer beeps twice: off the seat, can respond to some functions such as auto flush and water temp, seat temp adjust.

The buzzer beeps three times or more: it indicates that the product is faulty.

Hint: The buzzer only rings when the side knob is pressed, or when the remote is operated, or when drainage is initialized.

#### 预润净瓷Pre-flushing

着座后自动开启预润净瓷功能。当系统检测到着座时, 出少量水使陶瓷壁湿润, 避免因陶瓷壁太干燥导致挂污。

Automatically turn on the pre-flushing function after seated.

When the system detects seating, a small amount of water is released, wet the ceramic wall to avoid stains.

#### 自动断电Automatic power off

系统检测连续24小时无任何操作, 将自动关闭座圈加热。

- 当您和家人外出旅游或者出差时, 系统检测连续24小时无任何操作, 将自动关闭座圈加热。
- 当系统检测到有操作时, 自动恢复座圈加热功能至之前设置。

The system detects that there is no operation for 24 hours, and it will automatically turn off the seat ring heating function.

- When you and your family are traveling or on business, the system detects that there is no operation for 24 hours will automatically turn off the seat ring heat.
- When the system detects that there is an operation, it will automatically restore the seat heating function to the previous set.





## 常见故障诊断 Common Fault Diagnosis

如果发现类似故障，请先阅读以下内容尝试其处置方法来排解故障问题，若仍无法解决问题时，请联系销售单位或拨打客户服务中心电话进行联系。

Please read the following contents and try to solve the fault in other disposal methods if similar faults are found, or contact the sales department or call customer service center if the fault cannot still be solved.

### 电源开关 Power Switch

故障现象 Failure phenomenon	故障分析 Failure analysis	故障处理 Troubleshooting
产品不工作 Product is not working	检查是否有电/插座是否松动 Check if there is electricity / if the socket is loose	请检查电路 Please check the circuit
	检查产品电源是否开启（电源指示灯未亮） Check whether the power of the product is turned on (the power indicator is off)	按下电源/停止键，坐便器的电源指示灯点亮。 Press the power/stop button, the power indicator of the toilet will light up.
	是否漏电（漏电保护插头的显示灯未亮） Whether the leakage (the indicator light of the leakage protection plug is not on)	从插座上拔下电源插头，稍后再次插入。按下漏电保护插头的复位开关，若还是不能运行时，请拔掉电源插头，委托修理。 Unplug the power plug from the socket and plug it in again later. Press the reset switch of the leakage protection plug. If it still does not work, unplug the power plug and request repairs.

### 臀洗/妇洗 Rear Wash/Front Wash

故障现象 Failure phenomenon	故障分析 Failure analysis	故障处理 Troubleshooting
喷嘴不出水 No water from the nozzle	检查是否停水 Check if there is no water	待供水恢复 Wait for water supply to recover
	检查角阀是否关闭 Check whether the angle valve is closed	打开角阀 Open the angle valve
	检查进水过滤器是否被堵死 Check if the water inlet filter is blocked	清洗过滤网或更换过滤器 Clean the filter or replace the filter
	检查进水管是否折弯 Check if the water inlet pipe is bent	排除过滤器折弯 Eliminate filter bends
清洗强度不够 Insufficient cleaning	检查清洗水压是否在最低档 Check whether the cleaning water pressure is at the lowest level	参照说明书调节水压 Adjust the water pressure according to the instructions
	检查进水过滤器是否被堵塞 Check if the water inlet pipe is bent	排除过滤器折弯 Eliminate filter bends
喷嘴乱出水 The nozzle did not discharge water according to the operation	异常操作 Abnormal operation	拔出插头一分钟后重新通电 Unplug the plug and re-energize it after one minute
水温不够 Not enough water temperature	检查水温是否在低档 Check if the water temperature is at a low level	参照说明书调节水温 Refer to the instructions to adjust the water temperature
清洗管常滴水 Nozzle often dripping water	电磁阀失效 Solenoid valve failure	请专业人员维修 Ask a professional to repair
清洗功能不能正常使用 The cleaning function cannot be used normally	座圈下方是否有其他硬物撑住座圈 Whether there are other hard objects under the seat ring supporting the seat ring	移除硬物 Remove hard objects
	座圈人体感应失效 Seat body induction failure	请专业人员维修 Ask a professional to repair

## 暖风烘干/风温 Warm Air Drying/Wind Temperature

故障现象 Failure phenomenon	故障分析 Failure analysis	故障处理 Troubleshooting
烘干吹冷风 Drying blow cold air	检查烘干是否设置在关闭档 Check whether the drying temperature is set at normal temperature	参照说明书调节暖风 Adjust the drying temperature according to the instructions
	烘干加热部件是否损坏 Whether the drying heating parts are damaged	请专业人员维修 Ask a professional to repair

## 座温 Seat Temperature

故障现象 Failure phenomenon	故障分析 Failure analysis	故障处理 Troubleshooting
座圈温度过低/不加热 Seat ring temperature is too low/not heating	检查座圈温度是否设置在关闭档 Check whether the seat ring temperature is set at normal temperature	参照说明书调节座温 Adjust the seat temperature according to the instructions
	是否开启节电功能 Whether to turn on the power saving function	参照说明书关闭节电功能 Refer to the manual to turn off the power saving function

## 遥控器 Remote Control

故障现象 Failure phenomenon	故障分析 Failure analysis	故障处理 Troubleshooting
遥控器失灵 Remote control fails	电池电量过低 Battery is too low	请更换电池 Please replace the battery
遥控器按键无反应 The remote control button does not respond	某些功能有先决条件，某些功能互相排斥 Some features have prerequisites, some are mutually exclusive	请仔细阅读说明书 Please read the instructions carefully
遥控器指示灯不亮或显示明显变暗时，或者5号指示灯闪烁 When the remote control indicator does not light up or the display is obviously dimmed, or the No.5 indicator light flashes	电池电量过低 Battery is too low	请更换电池 Please replace the battery

## 陶瓷 Ceramic Bowl

故障现象 Failure phenomenon	故障分析 Failure analysis	故障处理 Troubleshooting
水压低时冲洗不干净 Not clean when the water pressure is low	过滤器堵塞 Filter clogged	按照说明书清洗过滤器 Clean the filter according to the instructions
	水管水压过低 Water pipe pressure is too low	检查水量是否10秒小于3L，建议购买增压泵 Check if the water volume is less than 3L in 10 seconds, it is recommended to buy a booster pump
	管路弯折 Pipe bend	检查管路是否有弯折现象，请保持供水管路顺畅 Check whether the pipeline is bent, please keep the water supply pipeline smooth
水压正常时无虹吸冲洗不干净 Cannot rinse clean when the water pressure is normal(No siphon)	排污口漏气 Air leakage at the sewage outlet	请专业人员进行维修 Ask a professional for repair
	S弯管堵塞 S elbow is blocked	请在当地市场购置皮栓进行疏通处理 Please purchase leather plugs in the local market for dredging treatment
水压正常时冲水不工作 Flushing does not work when the water pressure is normal	冲洗阀故障 Flush valve failure	请专业人员进行维修 Ask a professional for repair

## 其他 Other

故障现象 Failure phenomenon	故障分析 Failure analysis	故障处理 Troubleshooting
座盖/座圈下落过快 Seat cover/seat ring falling too fast	阻尼缓降功能失效 Damping slow down function fails	请专业人员进行维修 Ask a professional for repair

## 技术参数 Technical Specification

额定电压 Rated voltage	220V~	
额定频率 Rated frequency	50Hz	
额定消耗功率 Rated power consumption	1200W (进水温度15°C ± 0.5°C) (Inlet water temperature 15°C ± 0.5°C)	
使用环境温度 Ambient temperature	5°C-40°C	
进水温度 Inlet water temperature	5°C-35°C	
供水方式 Water supply method	角阀1/2 Angle valve 1/2	
进水水压范围 Inlet water pressure range	最低必要水压 Minimum necessary water pressure	0.14MPa且保证流动时水流量在18L/min以上 0.14MPa and ensure that the water flow is above 18L/min
	最高水压 Maximum water pressure	0.75MPa
坐便器 Toilet	冲水方式 Flush mode	喷射虹吸式 Siphon Flushing
	坑距 Pit distance	305/400mm
清洗 cleansing	温水加热方式 Warm water heating method	即热式加热 Instant heating
	温水温度 Warm water temperature	4档可调: 常温档、33°C、36°C、39°C 4-paragraph adjust: Room temp、33°C、36°C、39°C
	安全装置 Safety devices	温度传感器系统、防干烧系统、过温保护系统、水电隔离系统 Temp sensor control system、Dry burning-resistant protection device、over temp protection system、water and electricity isolation system
暖风烘干 Warm air drying	暖风温度 Warm air temperature	4档可调: 35°C、42°C、48°C、54°C 4-paragraph adjust: 35°C、42°C、48°C、54°C
	风速 Wind speed	≥4m/s
	安全装置 Safety devices	可恢复温度开关/熔断器 Temperature reset swith/fuse
座圈 Seat	座圈温度 Seat temperature	4档可调: 常温档、33°C、36°C、39°C 4-paragraph adjust: Room temp、33°C、36°C、39°C
	安全装置 Safety devices	温度传感控制系统/熔断器 Temperature sensing control system/fuse
防水等级 Waterproof level	IPX4	
电源线长度 Power cord length	1.5m	
产品尺寸 Product Size	LWH:687x419x467mm	



## 产品售后保修条款

本产品是在高质量标准及生产工艺下制造的，本公司承诺为消费者购买的产品提供有限期免费保修及终身维修服务。材质为陶瓷的部件免费保修期为5年，非陶瓷材质部件，如智能盖板、智能一体机的盖板组件、水箱内的水件、冲洗阀、坐便器盖板等免费保修期为3年，均自消费者购买日（以本产品分销商开具的发票或收据上载明日期为准）起计。免费保修范围为产品及产品配件（如水箱配件，坐便器盖板等）由于材质及工艺原因而造成的故障或损坏。免费保修期内，我们将无偿为您提供维修服务及更换发生故障的产品或产品配件。本公司的售后服务责任仅限于对故障产品的修理，而不延及您因产品故障而发生的其他损失，法律另有规定的除外。

您需了解：产品外观碰伤、刻划痕迹，以及滥用及不正当保养所导致的故障或损坏，均不属于免费保修范围。即使在免费保修期内，属下列（1）-（5）情况之一的，需酌情收取修理费用：

1. 不能出示相符的保修卡和有效购买凭证情况的；
2. 未按使用说明书告知的使用方法和注意事项造成的故障；
3. 自行拆卸、维修、改装所造成的故障和损坏；
4. 由于不可抗力等外部原因引起的故障和损坏；
5. 由于运输、搬运、挤压等造成的损坏。

对于保修期外或不在保修范围内的产品，如需维修，本公司将酌情收取上门费、人工费及材料费。

本保修条款仅对原始消费者和酒店行业的购买者有效，并不适用于本产品工业、商业、贸易和非酒店行业的使用。

如对本保修条款内容有任何疑问，请拨打400 630 8866 咨询热线，或向当地分销商咨询。对于中国大陆以外的市场，此产品的保修及保障服务详情请咨询当地经销商。

本公司对本产品保修拥有最终解释权。

## PRODUCT LIMITED WARRANTY

We offer limited warranty and lifetime maintenance for the products, which are all manufactured with high standards of workmanship.

The free warranty period for ceramic parts is 5 years, non-ceramic parts, such as the intelligent toilet seat, water fittings, flush valve, toilet lid, etc. is 3 years, both since the consumer's purchase date (based on invoices or receipts issued by the product distributors).

This warranty is your coverage against material and workmanship malfunction or defects in the products or components (water tank accessories, toilet cover, etc.). During the warranty period, we offer free maintenance and changing of malfunctioned products or product components. The company's after sales service liability is limited to the maintenance of faulty items and does not cover your other losses caused by product malfunction, except for otherwise stipulated by law. Cosmetic damages (scratches, dents, etc.) and malfunction or defects caused by abuse or improper maintenance is not covered by this warranty. Although the warranty period remains valid, in case of the following conditions (1) - (5), the maintenance cost (material cost and labor cost) shall still be charged as the case may be:

1. Corresponding warranty card and valid invoice cannot be presented;
2. Faults were caused by the incompliance with the instructions and precautions provided in the user's manual;
3. Damages and faults were caused by self-actuated dismantling, repair and refit;
4. Faults and damages were caused by external factors such as force majeure;
5. Damages were caused by transportation, unloading and extrusion, etc.

This warranty is valid for the original consumers only (including hotel use), and excludes industrial and commercial use of the product (except for hotel use). This card is only responsible for product maintenance rather than any other liabilities.

In the event that the product requires maintenance but exceeds the warranty period, or that the product is not covered by this warranty, labor cost and material cost shall be charged as the case may be.

Please call 400-630-8866 or contact local dealer for any question. For markets exclude Chinese mainland, the terms and conditions of warranty shall differ between product categories and countries. Please refer to warranty stated by local distribution.

The company shall have the final interpretation of the product warranties.

**MOEN® 摩恩®**

**合格证**  
Compliance Certification

产品名称 智能坐便器  
Product Name Intelligent toilet

检验员 \_\_\_\_\_  
Inspector \_\_\_\_\_

生产日期 \_\_\_\_\_  
Date of Production \_\_\_\_\_

富俊汇赢科技（上海）有限公司  
中国（上海）自由贸易试验区新杨公路  
1800弄1号4幢207室  
邮编：201413

Fortune Brands Innovations (Shanghai) Co., Ltd  
Room 207, Building 4, No. 1, Lane 1800, Xinyang Highway,  
China (Shanghai) Pilot Free Trade Zone



摩恩服务小程序  
Moen service applet